

یراق استیل

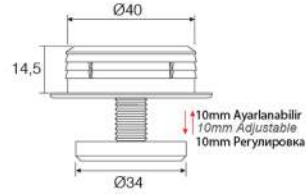

YME-PTG



YME-HE

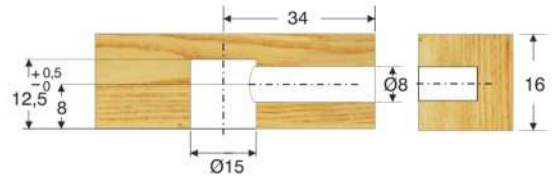

YME-E2-8

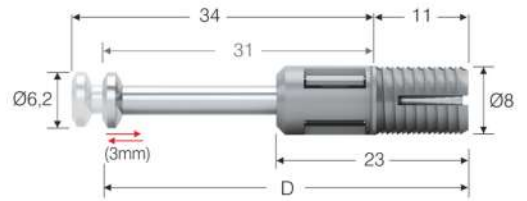

YME-E2-10

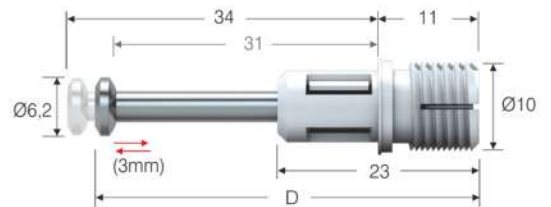

YME-PE

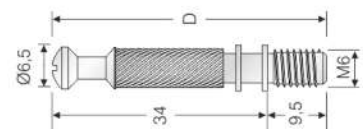

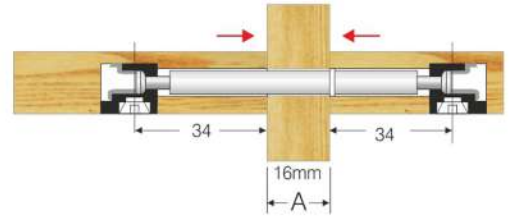

YME-ED-84

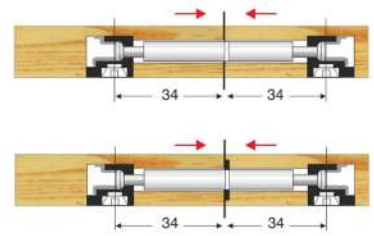

YME-ED-68

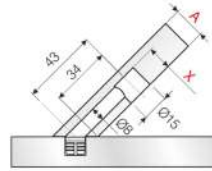

YME-EM-12

A	X
16	12,5
18	13,5

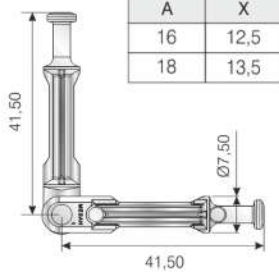

A	X
16	12,5
18	13,5

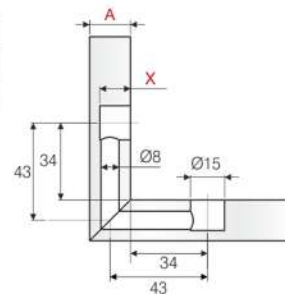

YME-EM-41

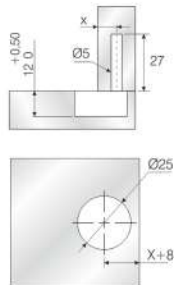

YME-EG-L



YME-PS-30

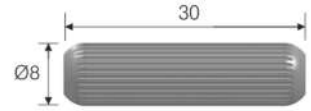
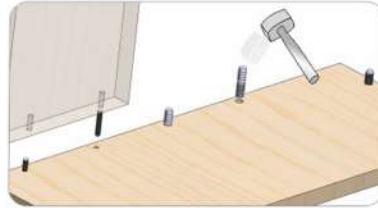

YME-PK-32

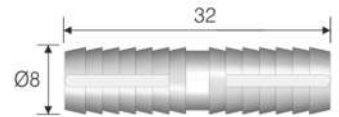
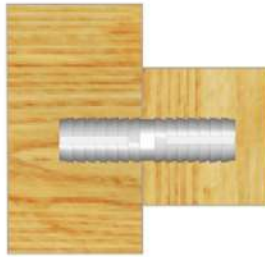

YME-RE-10

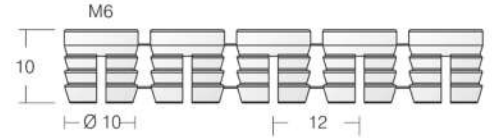
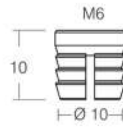

YME-RE-8

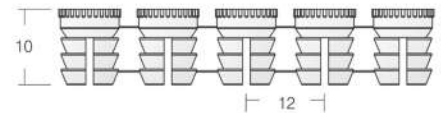
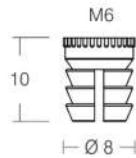

YME-MBP-10

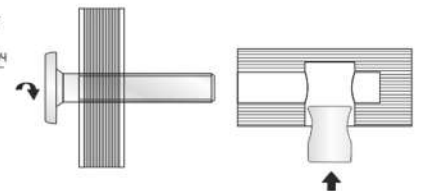
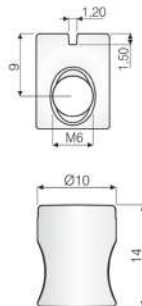

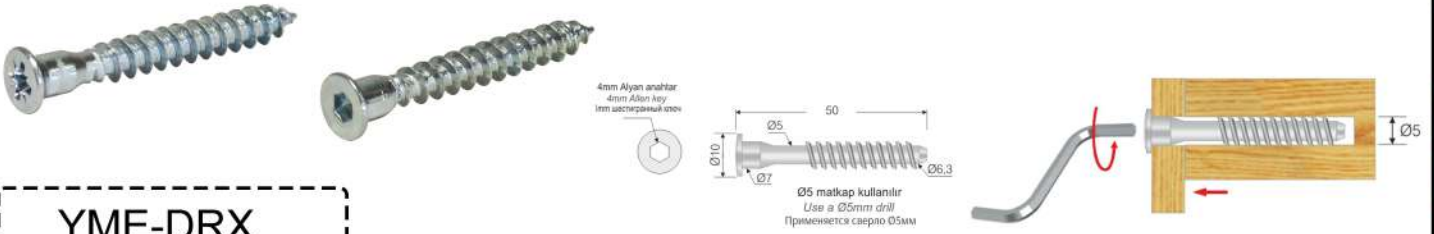

YME-DRX



YME-PTD

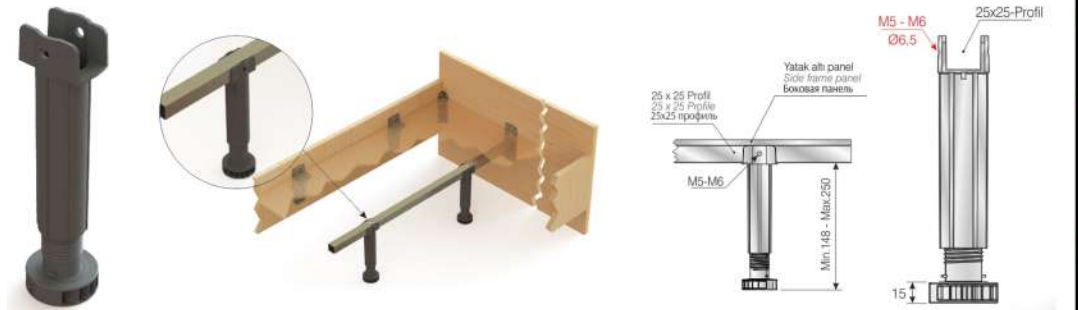

YME-PTU

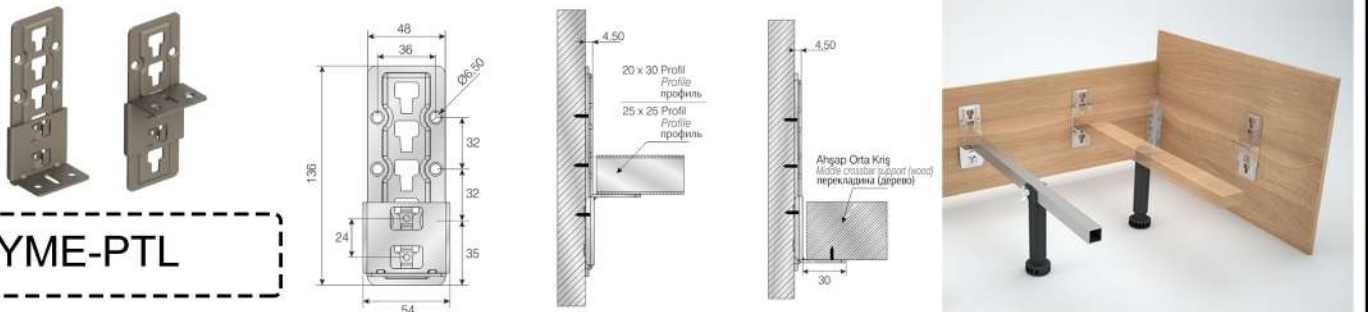

YME-PTL

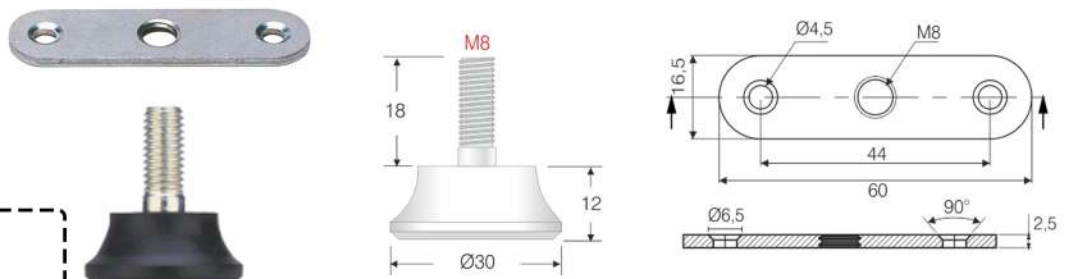

YME-PR3



YME-GDB

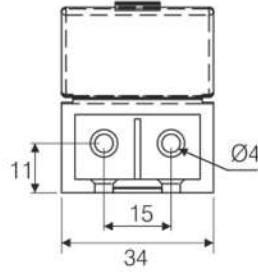
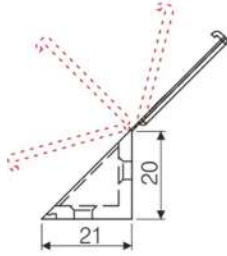

YME-GDS

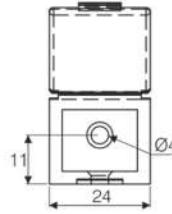
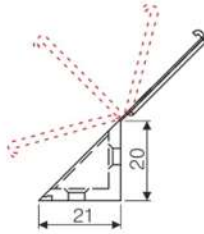

YME-EKL

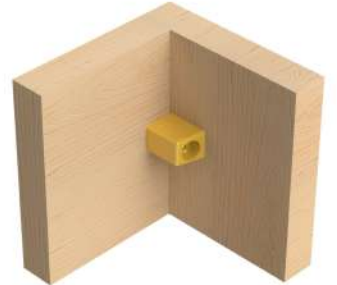
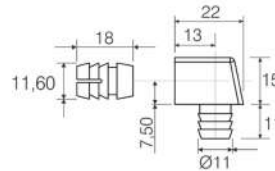
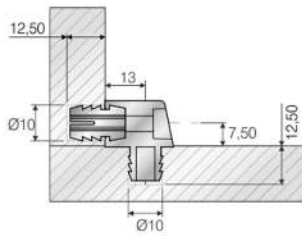

YME-SDS

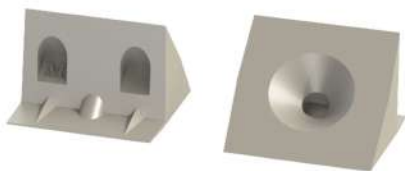
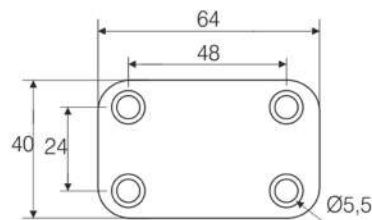

YME-GOV



YS-GP



YME-KT1

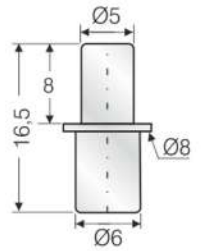

YME-KT2

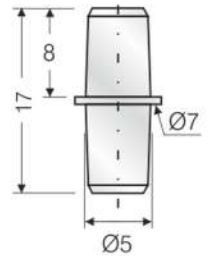

YME-KT3

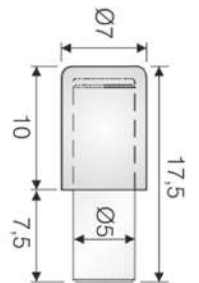

YME-KT4

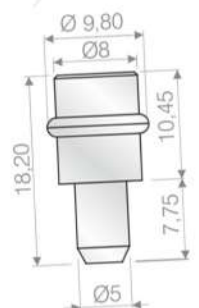

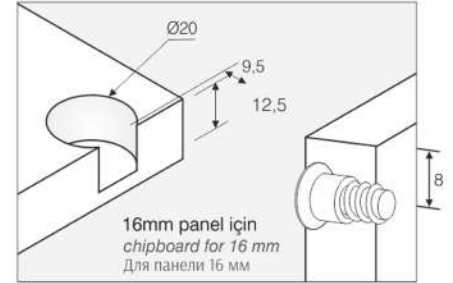
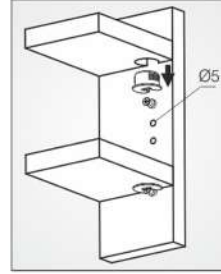
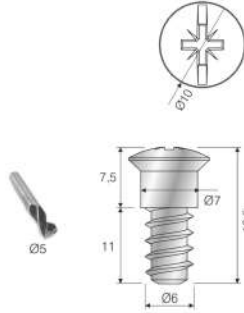
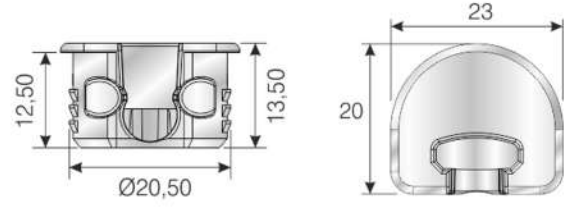

YME-ST

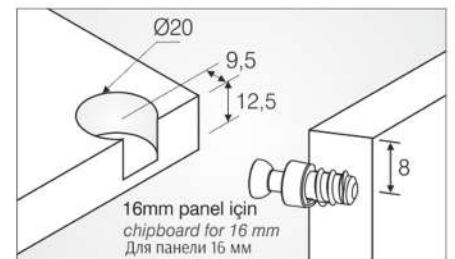
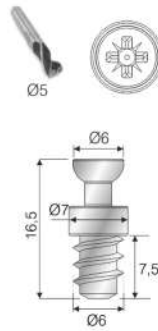

YME-RF

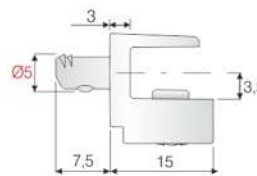
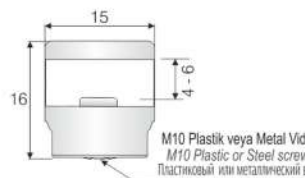

Plastik vida M10  
M10 Plastic screw  
Пластиковый  
винт M10

YME-ATS





YME-AP

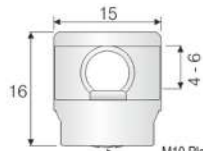

M10 Plastik veya Metal Vida  
M10 Plastic or Steel screw  
Пластиковый или металлический винт

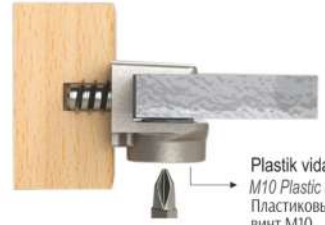
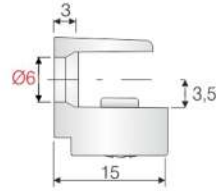

Plastik vida M10  
M10 Plastic screw  
Пластиковый  
винт M10



YME-SMS



6 ile 8 mm cam raf  
For 6-8mm glass  
Для стекла 6-8мм

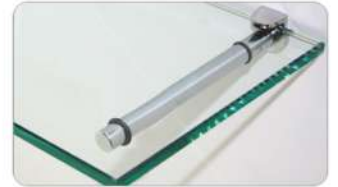
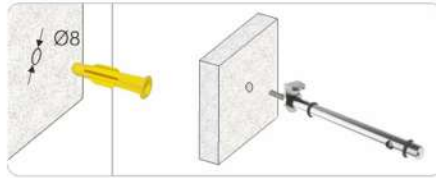

YME-SCD

250 x 700 mm ahşap raf için maksimum  
yükleme kapasitesi 10kg  
Max. load capacity for 250 x 700 mm wooden shelf is 10 kg  
Максимальная нагрузка на деревянную  
полку 250 x 700 mm 10 кг.

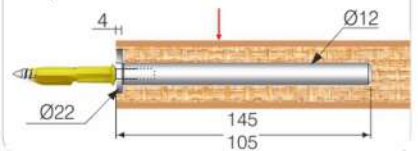

YME-SCS

250 x 700 mm ahşap raf için maksimum  
yükleme kapasitesi 10kg  
Max. load capacity for 250 x 700 mm wooden shelf is 10 kg  
Максимальная нагрузка на деревянную  
полку 250 x 700 mm 10 кг.

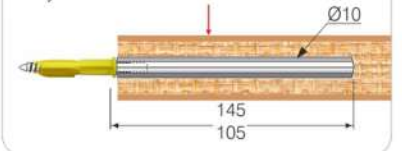

YME-PMM

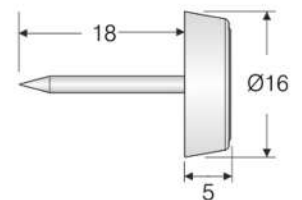

YME-PPK



YME-KPP

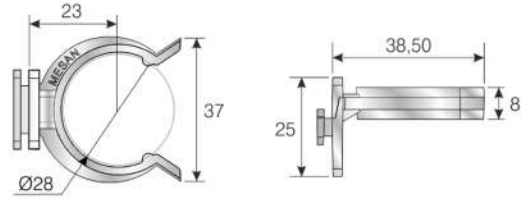

Alüminyum ve plastik baza profil klipsi ile kullanılır.  
 Plinth bracket for aluminium rail  
 Клипса для пластикового и алюминиевого цоколя

YME-KPT

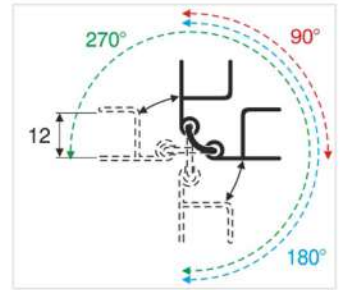

YME-P-10



YME-GRD

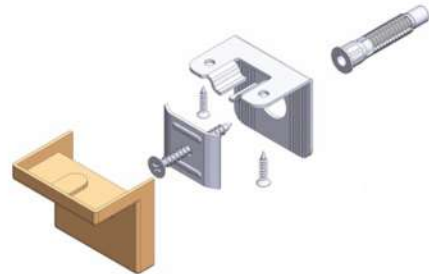
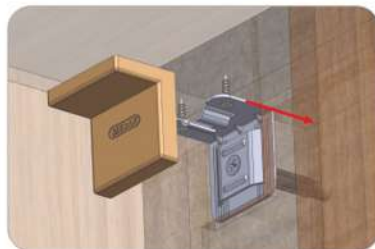

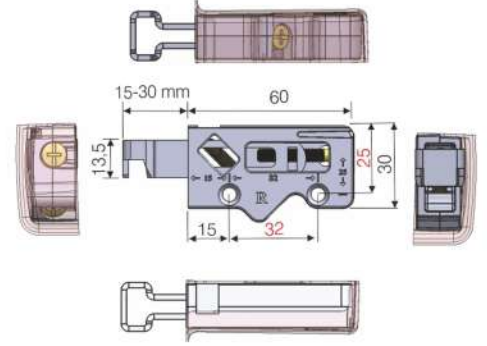
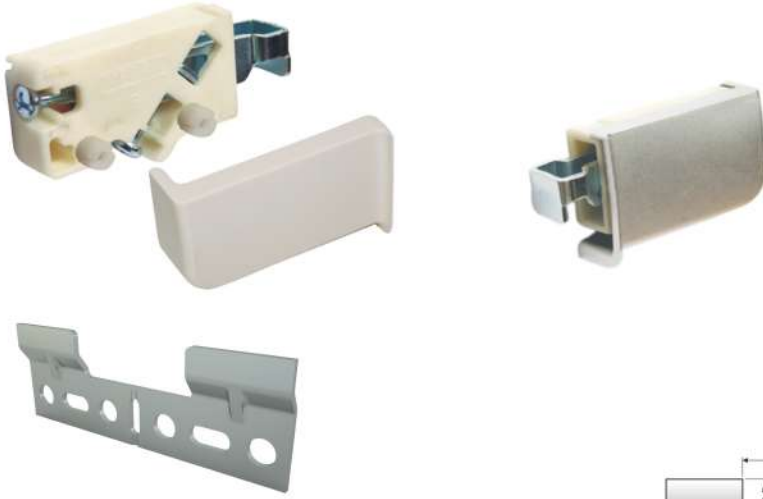

Load carrying capacity (1 set R+L) 150 kg

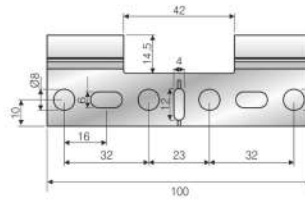

YME-FH1

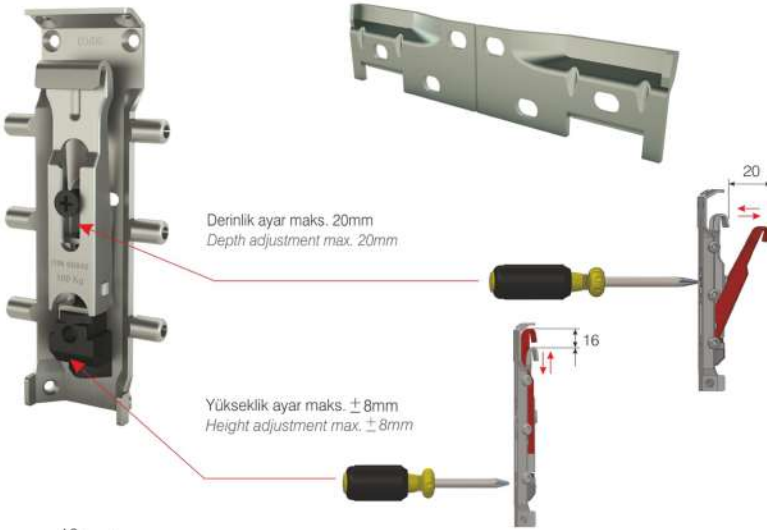

Derinlik ayar maks. 20mm  
Depth adjustment max. 20mm

Yükseklik ayar maks.  $\pm 8$ mm  
Height adjustment max.  $\pm 8$ mm



- Dolaba üstten herhangi bir bağlantı yoksa, gövdenin yukarısından 1/3 yüksekliğine kadar istenilen bölgeden monte edilebilir.
- Taşıma Kapasitesi: 100 kg / ad.
- If there is no top panel connection then the concealed cabinet hanger must be mounted in the upper third of the cabinet height !
- Loading capacity: 100 kg / pcs.

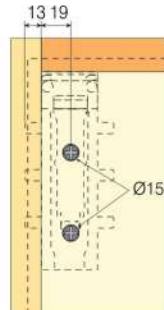
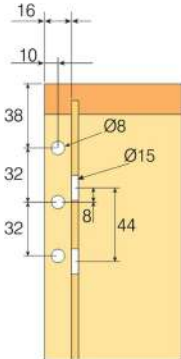

YME-FH2





YME-PG30

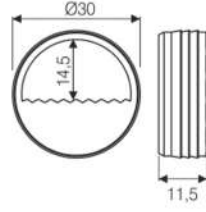

YME-PG25

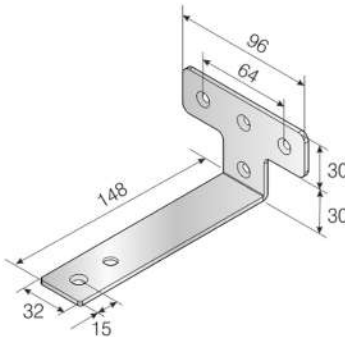
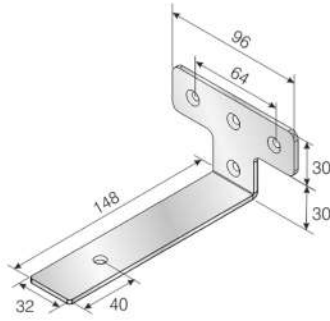
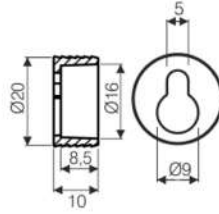

İstenilen  
Ölçü  
Kullanılabilir.

YME-PGU



YME-SZ1



YME-SG25



Taşıma Kapasitesi : 180 kg  
Load capacity : 180 kg



YME-SG15

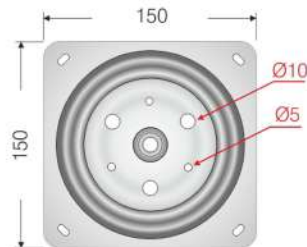

Taşıma Kapasitesi: 140 kg  
Load capacity : 140 kg



Kalınlık 2mm  
Thickness 2mm  
Толщина 2 мм



Taşıma Kapasitesi : 80 kg  
Load capacity : 80 kg  
Нагрузочная способность 80, кг

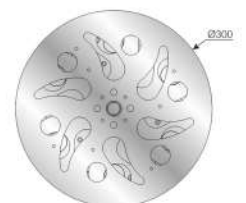
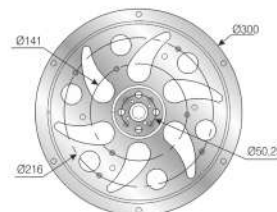

YME-SG30

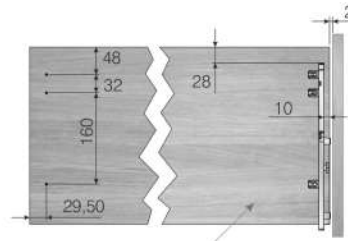

On Kapak  
Front Cover  
Передняя Крышка

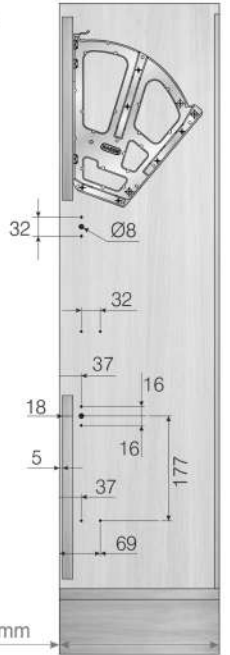
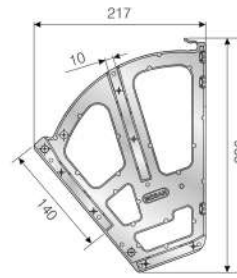
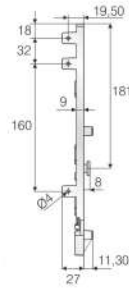

YME-JK2

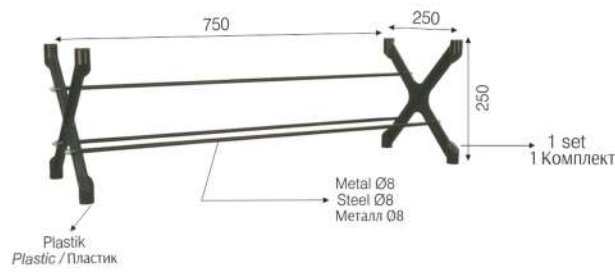

YME-JKT

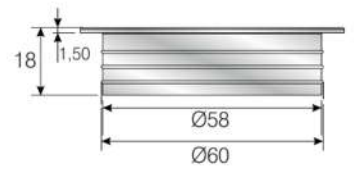
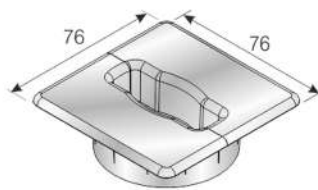

YME-JKM

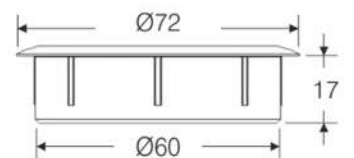

YME-JKG

30x30 profil  
30x30 profile  
30x30 профили

Cam Glass

Ø20

30

Ø26

32

Ø5

6 ile 8mm cam kullanilir  
Adjustable 6 to 8mm glass  
Для стекла 6-8мм

**YME-LSH**

The diagram illustrates the YME-LSH glass connection system. It shows a 30x30 profile being attached to a glass panel. The glass panel is labeled 'Cam Glass' and has a hole with a diameter of Ø20. The profile is secured with a bolt and nut. A detailed view shows the profile's dimensions: a hole diameter of Ø26, a distance of 32 between holes, and a hole diameter of Ø5. A note specifies that a 6 or 8mm cam is used, which is adjustable for 6 to 8mm glass. A photograph on the right shows a glass display cabinet with a similar connection system, with a circular inset providing a close-up of the hardware.

**YME-JCD**

14 CD kapasiteli  
14 CD capacity  
Вместимость 14 CD

13

13

224

119

133

The diagram illustrates the YME-JCD CD rack system. It shows a CD rack being inserted into a cabinet. The rack is labeled '14 CD kapasiteli' (14 CD capacity) and 'Вместимость 14 CD'. The rack's dimensions are shown: a height of 13, a width of 133, and a depth of 119. A photograph on the right shows a wooden cabinet with a CD rack installed, with a circular inset providing a close-up of the rack's structure.





Yaragh Steel

No.397 , Delavaran St. , Hengam St. ,

Sq Resalat , TEHRAN

 09213100801

 02177450881-02177200638

 [www.yaraghsteel.com](http://www.yaraghsteel.com)

 [yaraghsteel](https://www.instagram.com/yaraghsteel)

# Stay updated with us

CAGDAS

samet

FACTOR  
ELECTRONICS

MESAN  
FURNITURE EQUIPMENT

SACHIL

blum

NEPA